

# BFTA-37, 20kW

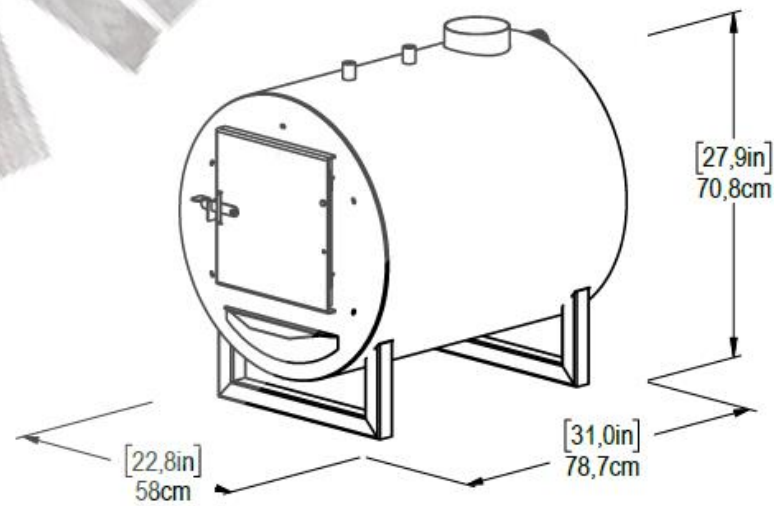

# BFTA-75, 24kW

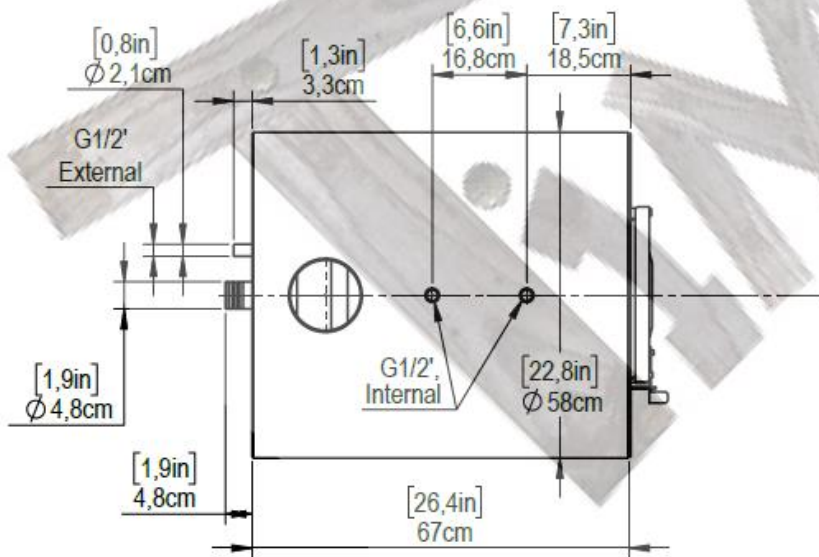
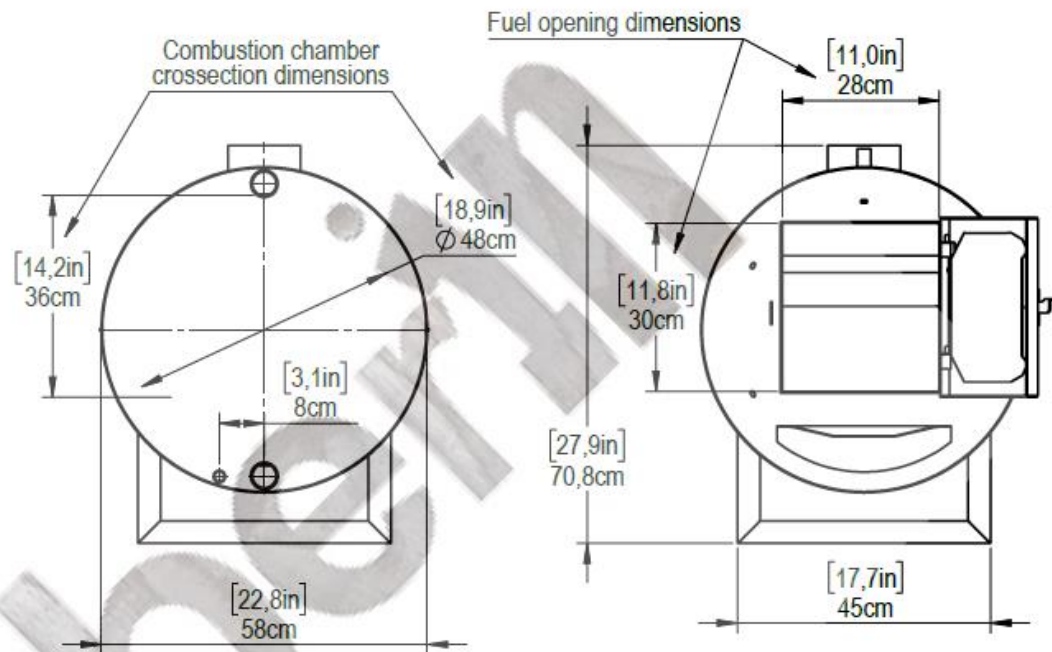
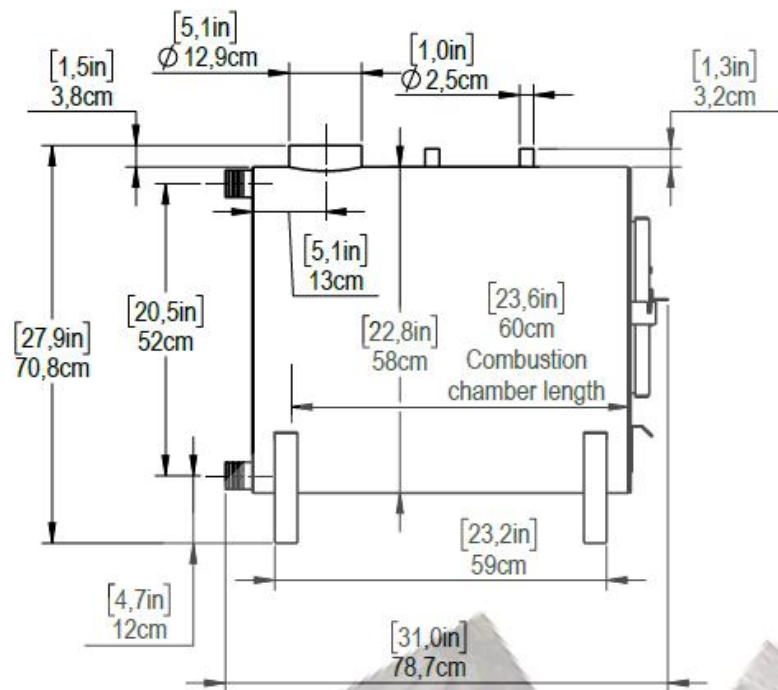
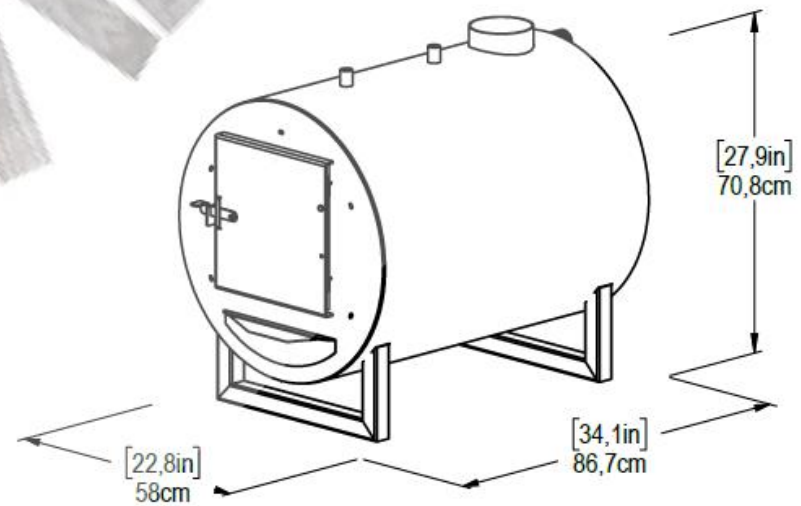
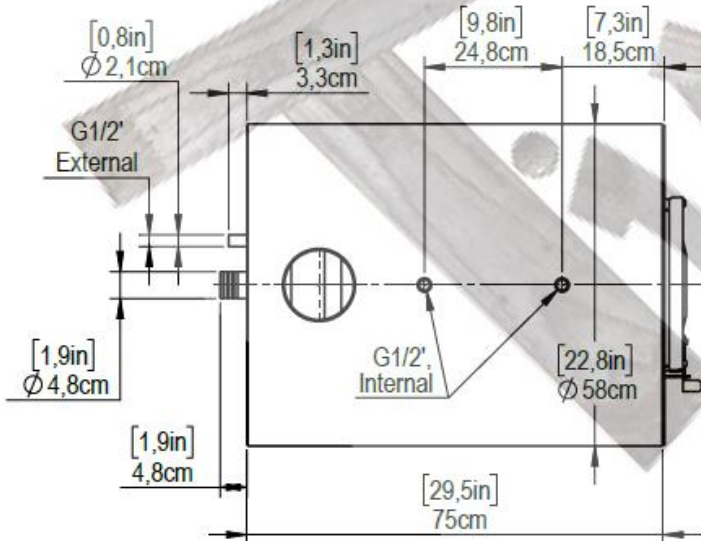
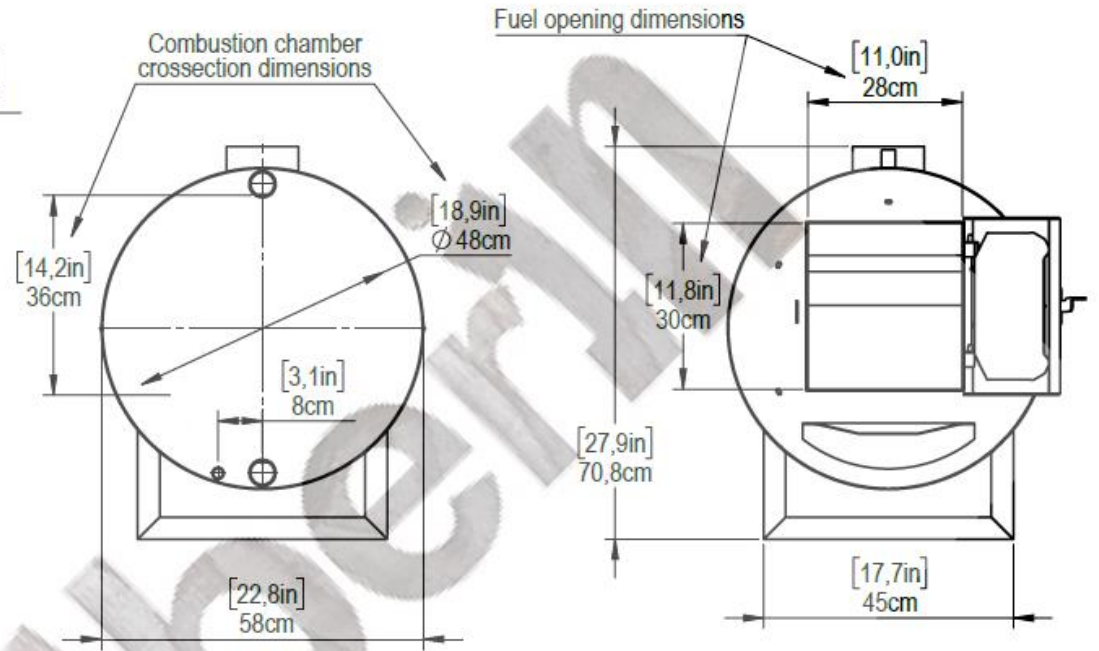
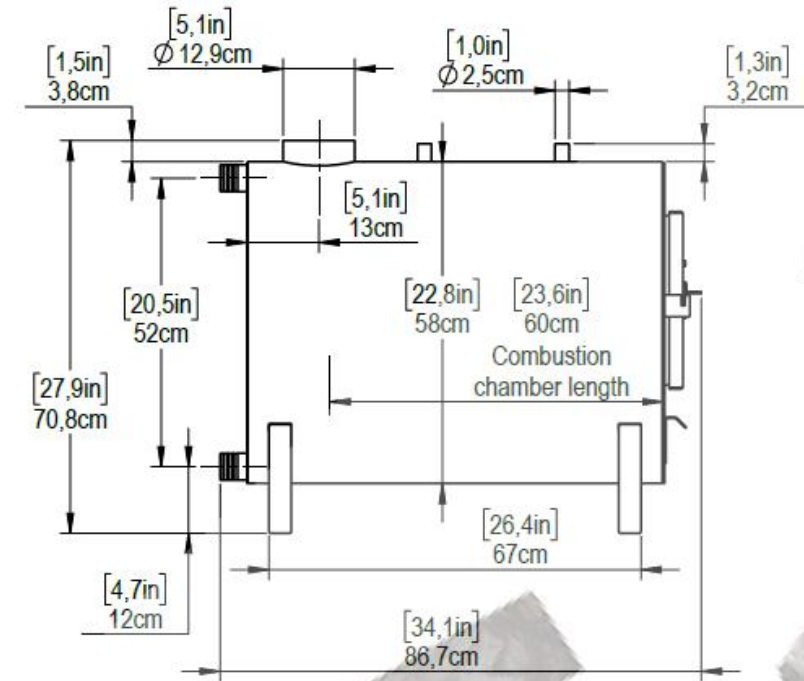

# BFTA-100, 40kW

